



IKE Q3 FY23 Performance Update

We're IKE, the Pole OS™ Company

Glenn Milnes, CEO

glenn.milnes@ikegps.com

7 February 2023

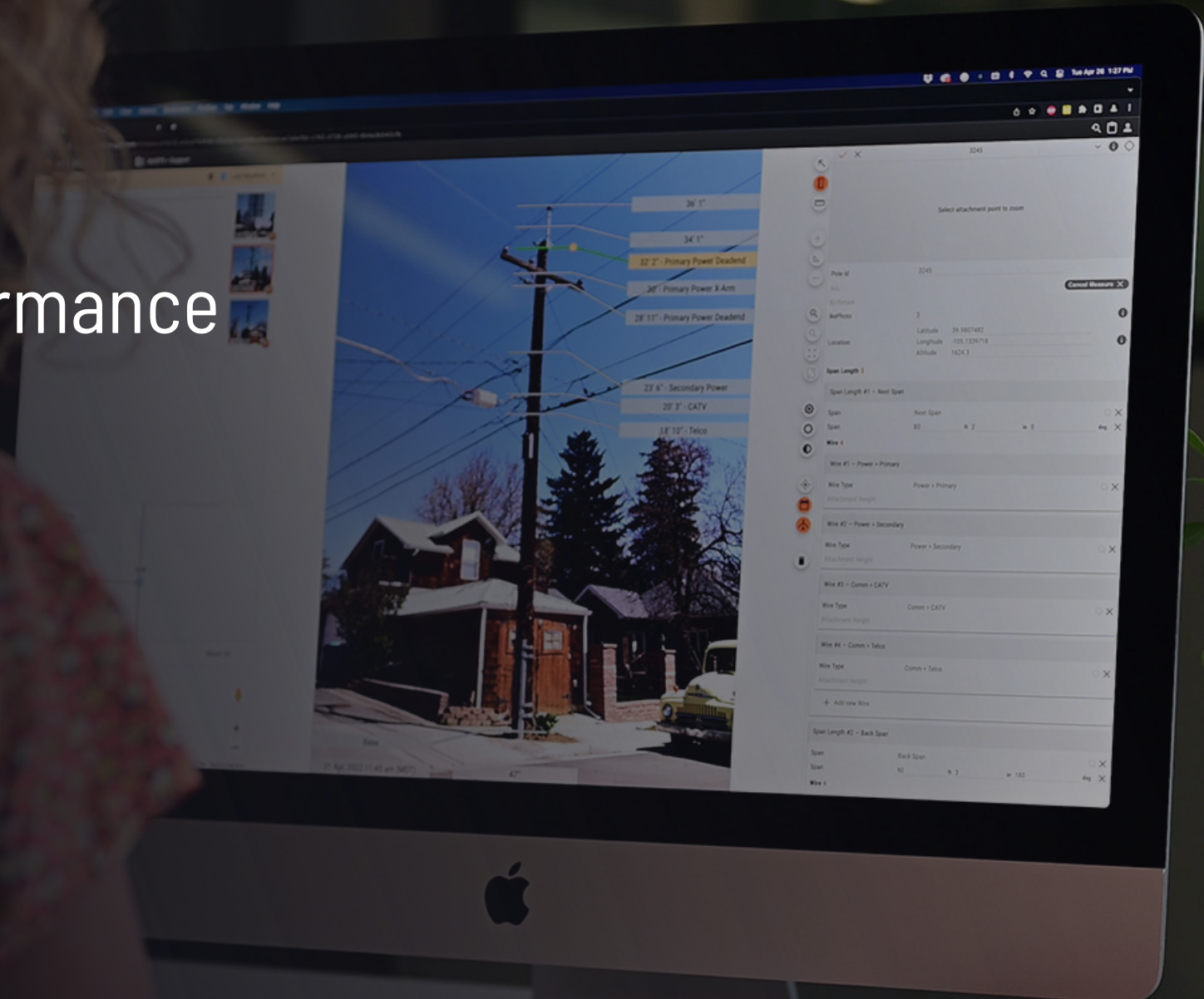



Important Notice

Information in this Presentation:

- Is for general information purposes only, and is not an offer or invitation for subscription, purchase, or recommendation of securities in ikeGPS Group Limited (IKE);
- Should be read in conjunction with, and is subject to, IKE's FY22 financial results (audited), 1H FY23 financial results (unaudited) recent market releases, and information published on IKE's website (www.ikegps.com);
- Includes forward-looking statements about IKE and the environment in which IKE operates, which are subject to uncertainties and contingencies outside of IKE's control – IKE's actual results or performance may differ materially from these statements;
- Includes statements relating to past performance, which should not be regarded as a reliable indicator of future performance; and
- May contain information from third parties believed to be reliable – however, no representations or warranties are made as to the accuracy or completeness of such information.
 - All information in this presentation is current at the date of this presentation, unless otherwise stated.
 - All currency amounts are in NZ dollars unless stated otherwise.

Receipt of this Document and/or attendance at this presentation constitutes acceptance of the terms set out above in this Important Notice.



Agenda and Contents

- Q3 FY23 financial results and performance update
- Market overview
- Team
- Technology and products
- Q&A

.



Revenue in nine months to December 2022 of ~\$23.3m (+134% pcp).

>\$20m revenue from recurring subscription and reoccurring transaction sources.

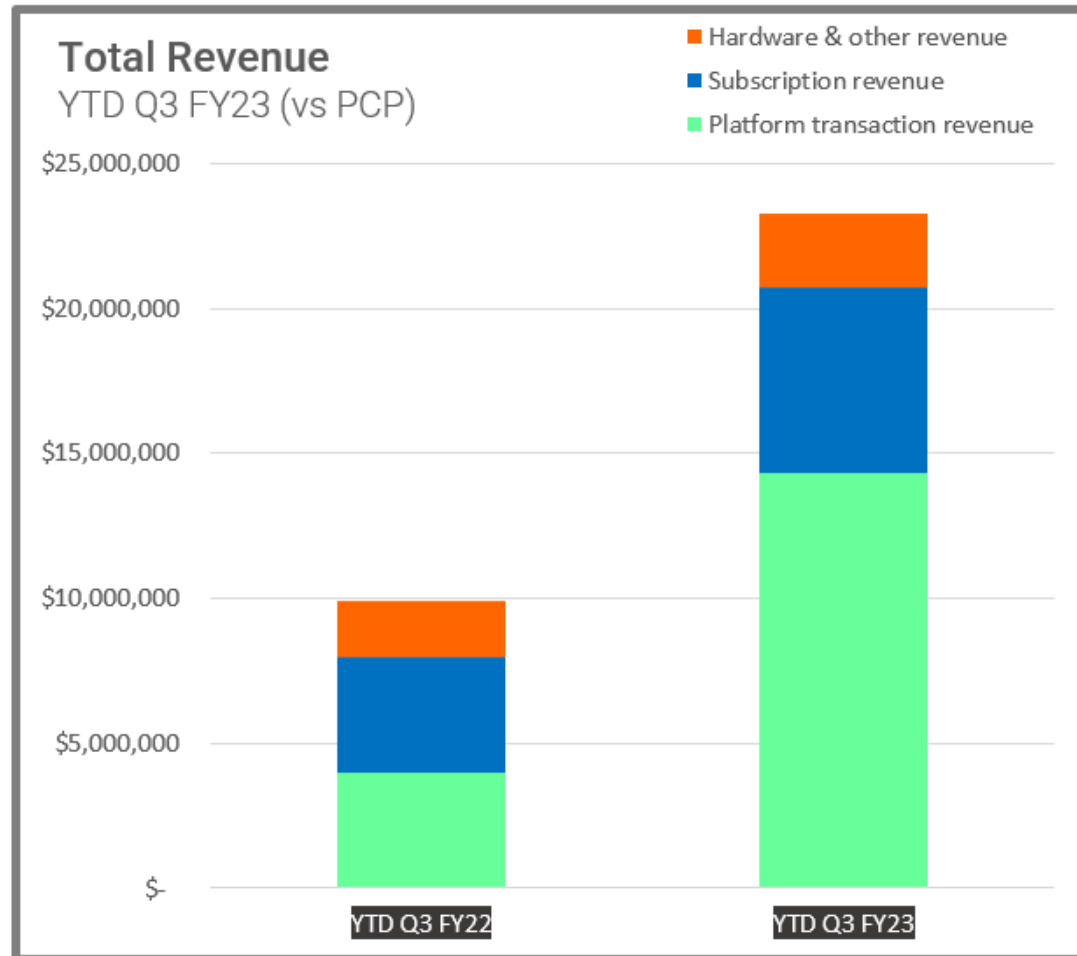

Takeaways:

- 134% total revenue growth against PCP.
- Recurring subscription and reoccurring transaction revenues (shown by the Green and Blue segments in this chart) dominate IKE's revenue mix, at >\$20m YTD.
- This element continues grow because of the investment into extending software products, underpinning more predictable growth with higher quality revenue.



A significant signed contract backlog supports a bullish growth outlook.

Additive to the signed contract backlog is a strong new opportunity pipeline.

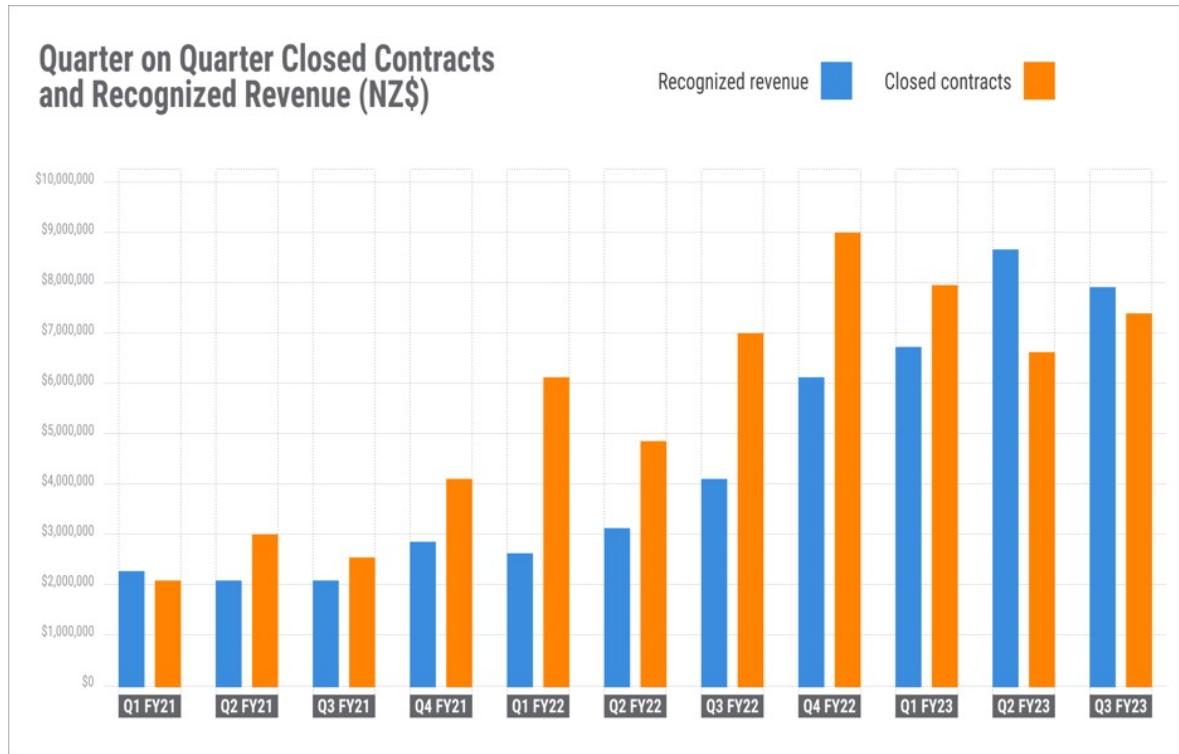

Takeaways:

- Chart shows the approximate nine-month correlation between the timing of signed contracts and subsequent timing to recognized revenue.
- This timing lag reflects that subscription and transaction contracts are delivered over time (normally 12 months), based on usage rates of IKE products by customers.



258% growth in transaction revenue vs pcp.

One of the primary indicators of platform utilization by IKE customers.

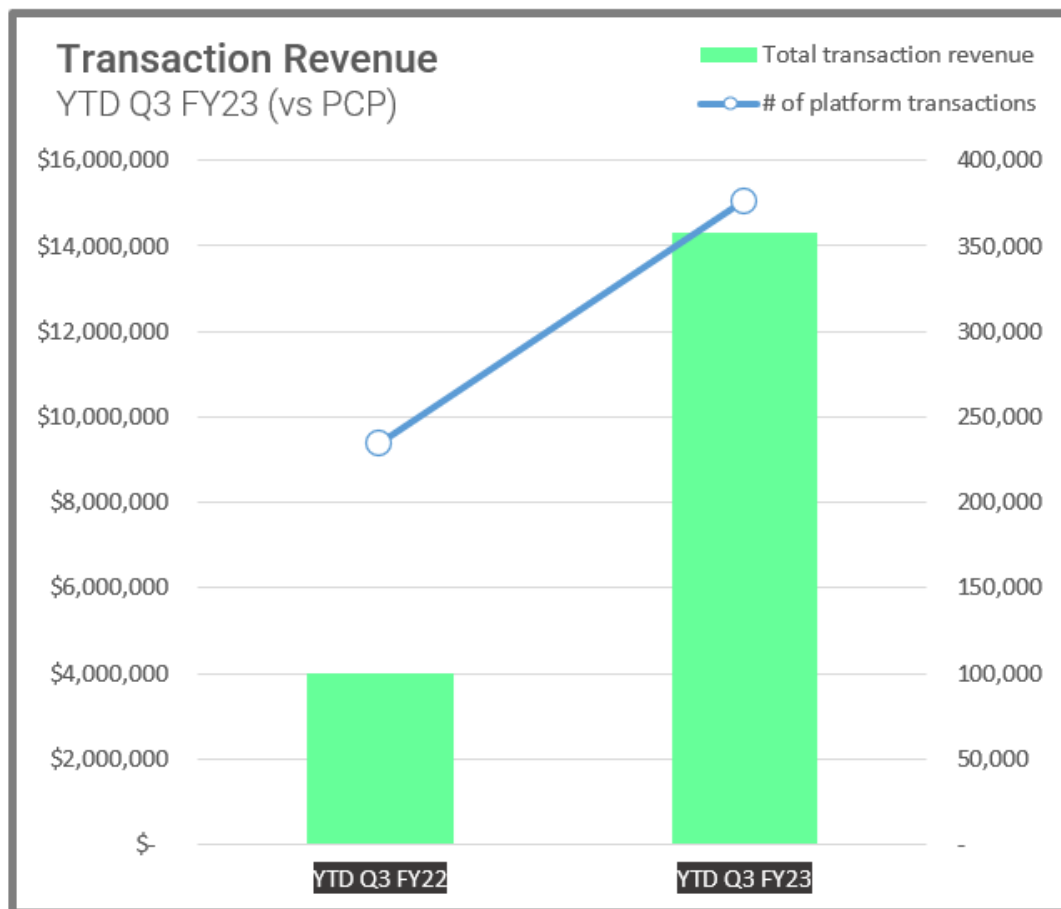

Takeaways:

- Significant growth in transaction revenue has continued, with >350k assets engineered on the IKE platform under the transaction model YTD.
- This is one of the primary indicators of platform usage by IKE customers and is expected to remain a growth driver for the business.



Key metrics

	YTD Q3 FY23	PCP (YTD Q3 FY22)	% Change
Total Revenue	\$23.3m	\$9.9m	+134%
Platform Transactions			
# of billable transactions	376k	234k	+61%
Platform transaction revenue	\$14.3m	\$4.0m	+258%
Gross Margin	\$5.3m	\$1.9m	+179%
Gross Margin %	37%	48%	
Platform Subscriptions			
# of enterprise customers	365	319	+14%
Platform subscription revenue	\$6.4m	\$4.0m	+60%
Gross Margin	\$5.7m	\$3.5m	+63%
Gross Margin %	89%	88%	
Hardware & Other			
Hardware & Services revenue	\$2.5m	\$1.9m	+32%
Gross Margin	\$1.3m	\$0.8m	+63%
Gross Margin %	52%	44%	

North American Market Opportunity & Timing



Current Market Dynamics Lead to Strong Tailwinds for IKE



Requirement for harder and higher capacity distribution power networks across all of North America

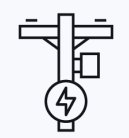

>3,200

Electric Utilities in North America with long-term, recurring distribution network hardening, joint use, and capacity needs for electrical distribution

7+ year macro-market tailwind of fiber deployment, much of it engineered on distribution power poles



>\$350B

Investment forecast in fiber in the US by 2025, representing >30M attachments; communications infrastructure providers seeking partners to manage new fiber attachments for every pole

Small Cell Deployments across North America, much of it engineered on distribution power poles



800,000+

Small cell site expansions are expected by 2025 as communications infrastructure providers look to speed up 5G rollout while reducing cost and time of deployment

Infrastructure development via Engineering Service Providers



>1,000

Engineering Service Providers in the US subcontracted by telecom and utilities providers to assist in infrastructure development and deployment



Growing Network Investment across Electric Utilities; Support Needed for Productivity Solutions such as IKE over the Coming Decades

\$NZD in B

U.S. AND CANADIAN ELECTRIC DISTRIBUTION CAPITAL EXPENDITURES

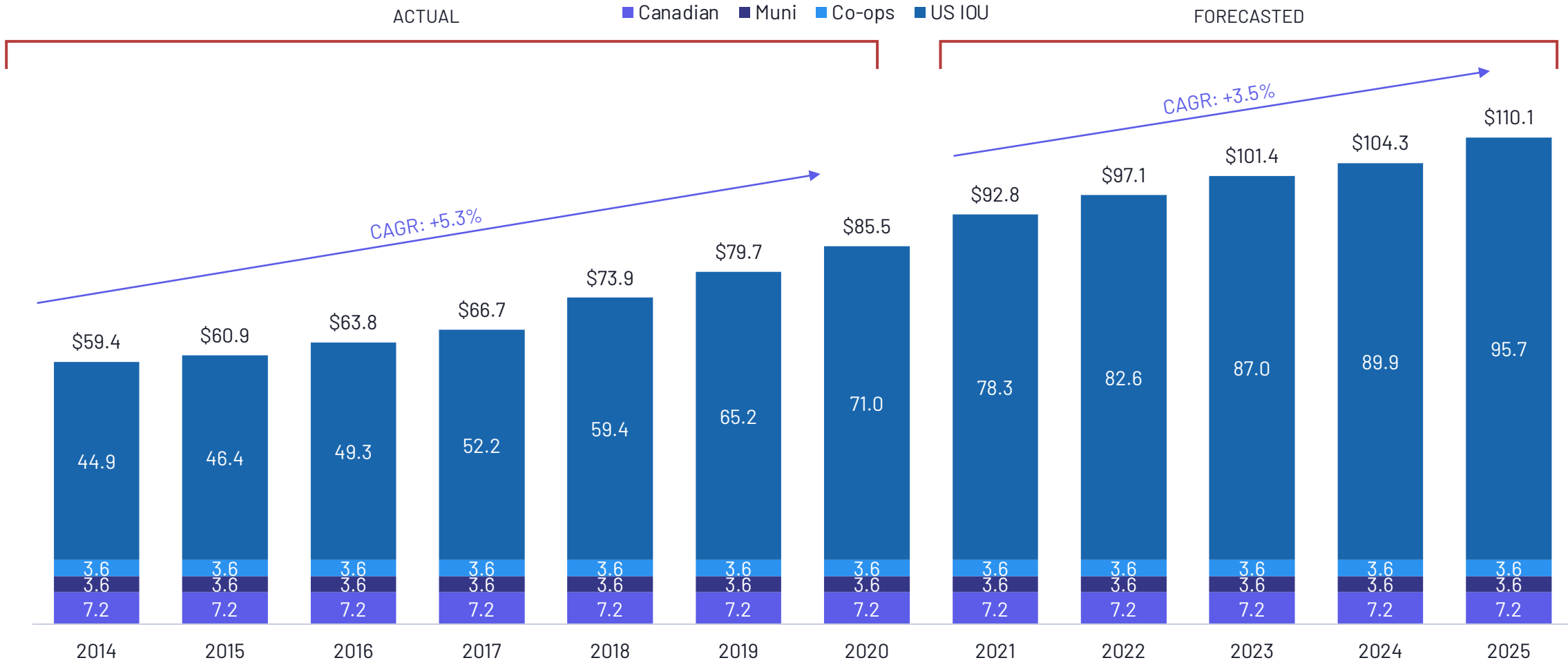



Fiber and 5G Investment Super-Cycle in North America Still In Its Early Stages

PROJECTED INVESTMENTS INTO 5G & FIBER OPTIC INFRASTRUCTURE

\$NZD

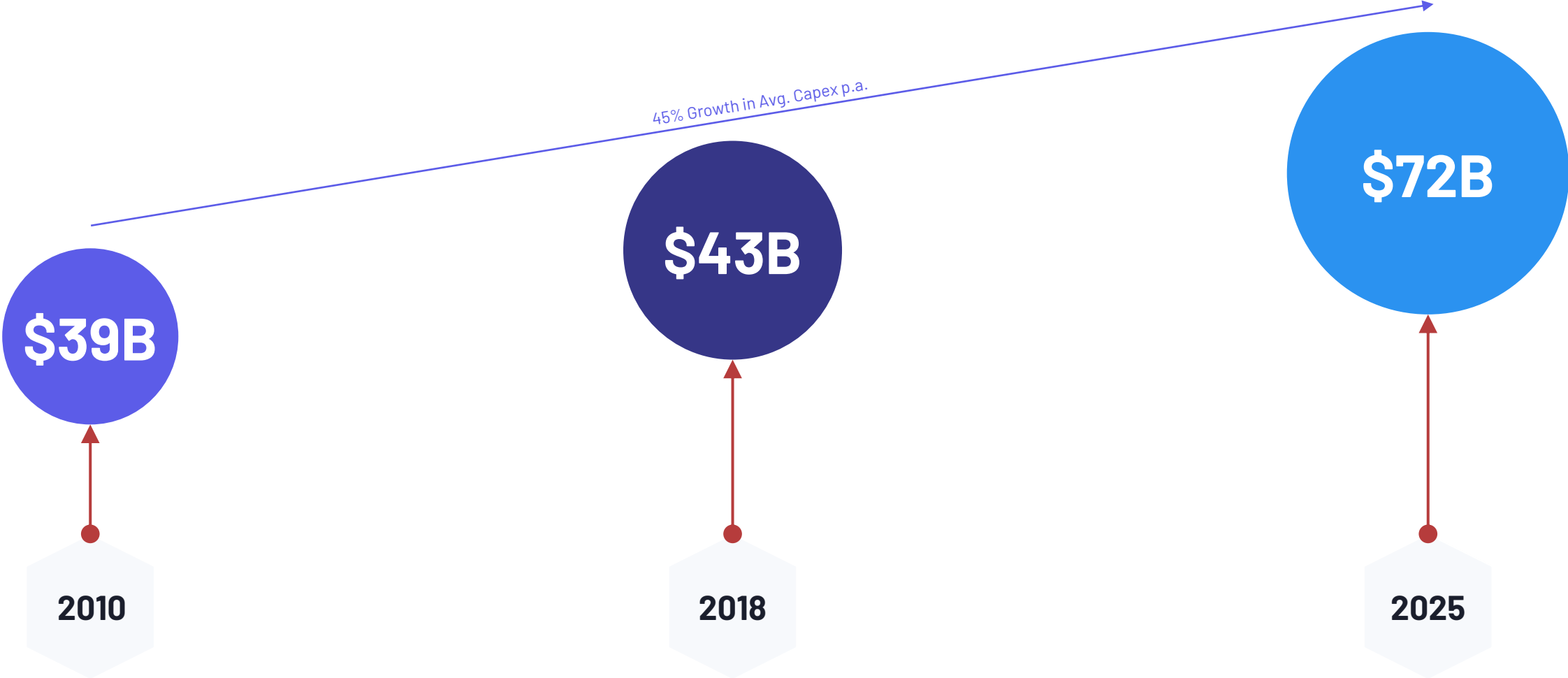

Source: Bell Potter Initiation of Coverage Report, GSMA, American Tower
Note: Labeled Capex Figures reflect Houlihan Lokey Estimates



Focused Use Cases for IKE Products and Technology

\$NZD



CIPs¹

Market Opportunity

- Consists of fiber & 5G network deployment
- 200+ CIPs in North America
- 650,000 cellular & small cell towers
- Over \$441.0bn of investment in fiber networks over the next 3+ years

IKE Use Case

- Improves speed of deployment
- Standardized data and cost of assessment per pole asset

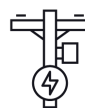

Electric Utilities

- 3,200+ electrical utilities in North America
- 220m poles used in electrical transmission & distribution
- \$4.3bn TAM per annum

- Network hardening
- Pole audits
- Faster joint-use assessment turnaround
- Standardized method of pole assessment



Engineering Service Providers

- 1,000+ engineering service providers in North America
- Conduct 50.0% of fieldwork and network development for CIPs & electric utilities

- More efficient means of data collection, leading to improved MRE permitting and faster deliverables

(1) Communications Infrastructure Providers
 Source: Management Estimates, Bell Potter Initiation of Coverage Report, Houlihan Lokey Estimate



Electric Utility Market macro tail winds

Addressing a large market opportunity across the U.S. electric utilities segment

> 3,200 electric utilities across the U.S. facing common challenges.

- Outages
- Aging infrastructure
- Potential catastrophic consequences
- Increased O&M costs
- Environmental clean-up costs
- Significant legal liability
- Regulatory and Engineering code compliance

> 2,000 Engineering Service Providers

IKE improves the engineering design and maintenance process of poles



Communications Market Macro market tail winds

Addressing a large market opportunity across the U.S. Communications segment

- >\$300B expected investment into fiber network development in the U.S over next 5+ years.
- >\$50B expected investment into 5G network development in the U.S. over the next 5+ years
- An additional >\$60B expected investment into rural broadband development as part of the Biden administrations new Infrastructure bill
- >200 Communications companies competing to build a networks and win underlying customers
- >1,000 engineering service providers supporting network development

IKE dramatically speeds up aspects of the network deployment process.



A Sticky Tier-1 Customer Base in Place

Telecom

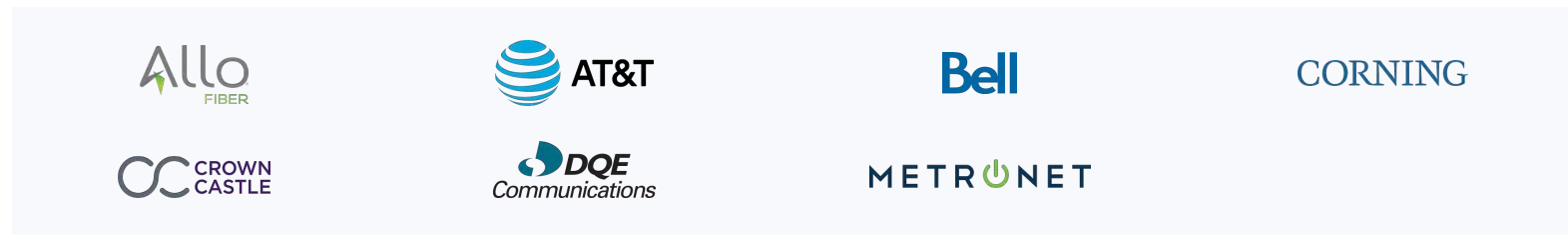

Electric Utilities



Engineering & Project Management



- 5 of the 10 largest Investor-Owned Utilities (“IOUs”) in North America
- >350 customers in North America, with 65 logos added in the past 12 months

Opportunities to:

- Materially grow, upsell and cross-sell IKE products into existing customer base
- Win new logos in the North American market, with >6,000 entities participating in this space
- Expand into international markets



Multiple Avenues Supporting Future Growth Potential



Team



Accelerating at IKE

Some of the key faces representing the next generation of our industry

IKE's people come for the job and the reputation of working at the company. They stay for the accelerated development of their careers. A few of the company's young, emerging superstars are showcased below.....

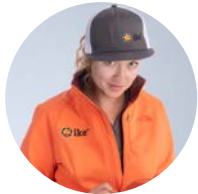

Liz Etzel

Product Manager: Knows virtually every customer and is persnickety about exemplary customer experience.



Jessica Walker

IKE Analyze Manager: Delivers every customer project on time and on scope. Started at IKE as an analyst.



Blake Collins

Solutions Engineering Manager: From the field to the office, Blake speaks and geeks on the complexities of utility pole dynamics.



Sara Deere

Systems Engineer: Current holder of the world-record for running customer field teams with the least recollects.



Dan Allan

Design Director: Loves CX, and lives its importance when delivery brand and CX specific to poles.



Spencer Hankin

Senior GIS Manager: The brightest data analyst in the Pole GIS universe, and customers like Crown Castle know it.

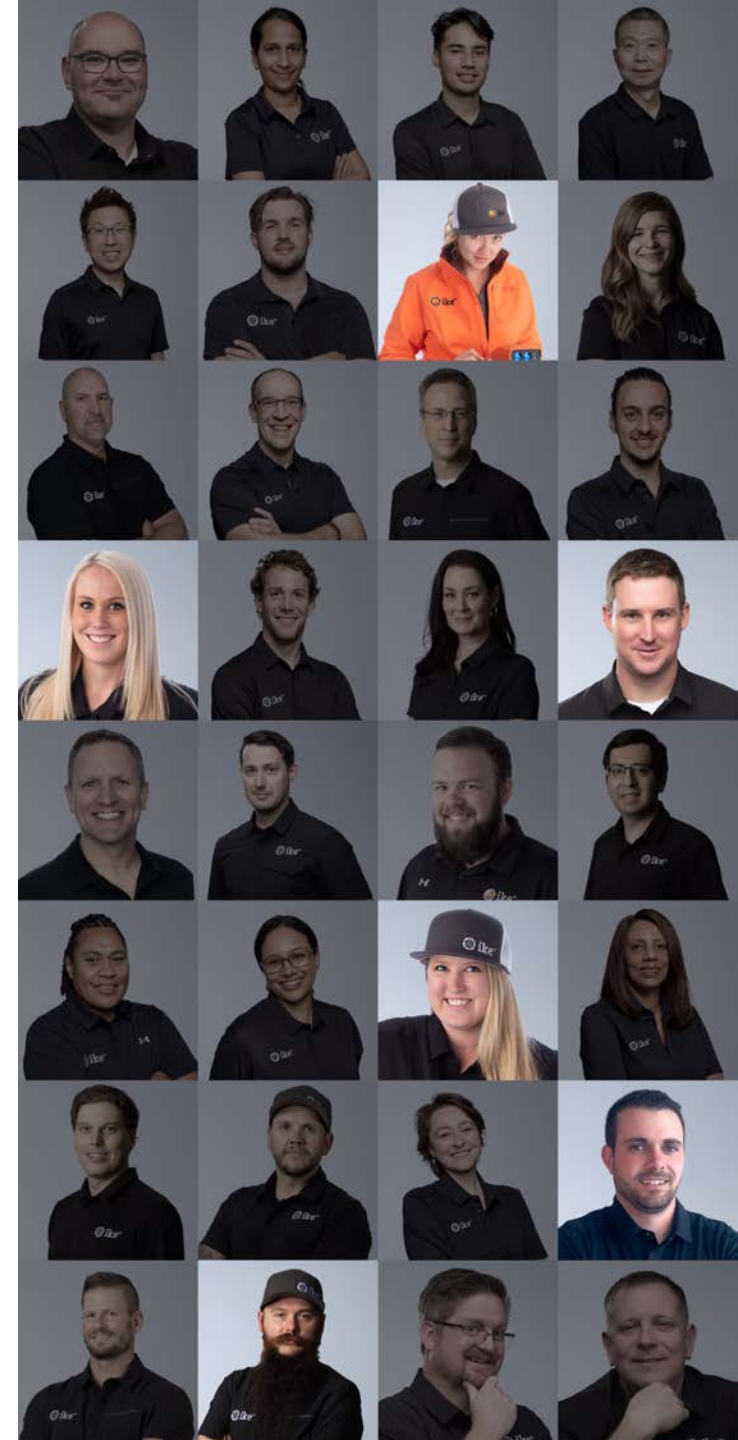



In-Market Leadership

A Direct Sales, Brand & Delivery Model Across North America



Glenn Milnes
Chief Executive Officer

Joined IKE in 2013



Lydia Siloka
Head of People

Joined IKE in 2020



Stephen Fairbrother
Chief Financial Officer

Joined IKE in 2018

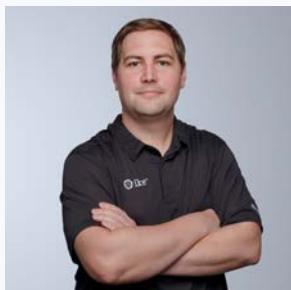

Jareth Rosking
Chief Information Officer and
Head of Engineering

Joined IKE in 2021



Malcolm Young
SVP Structural Analysis & Head
of IKE Structural

Joined IKE in 2019



Chris Ronan
Chief Marketing & Brand Officer

Joined IKE in 2020



Leon Toorenburg
Chief Technical Officer

Founded IKE in 2003

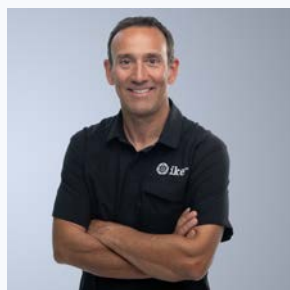

Chris DeJohn
SVP of Sales & Business
Development

Joined IKE in 2020

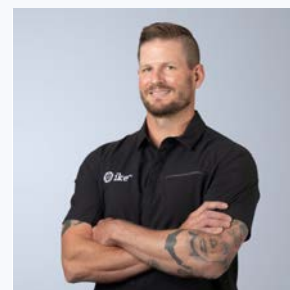

Jonathan Brigham
Director of Operations

Joined IKE in 2021





A Board with deep industry experience

Board of Directors

Alex Knowles

Chairman and Director

Alex has investing and operating experience with international companies in the information technology and transportation industries. Based in Los Angeles, He was formerly Chief Operating Officer of the largest international freight forwarder and small parcel consolidator in the U.S.

Eileen Healy / BS Electrical Engineering

Independent Director

Serial entrepreneur of two high-tech startups addressing the U.S. communications market including Healy & Co, that provides outsourced engineering to the U.S. utility market. Customers include AT&T Mobility, T-Mobile, Vodafone, Verizon Wireless, Frontier Communications, and FirstNet.

Mark Ratcliffe

Independent Director

Mark was the founding CEO of Chorus New Zealand from 2007 to 2017 where he led the deployment of New Zealand's national fiber network. Prior to Chorus Mark was CIO and COO of Spark (formerly Telecom NZ). Prior governance roles include Director of 2 Degrees from 2017 to 2020. The majority of his current portfolio is in the Infrastructure Sector and he is currently the Chair of First Gas, Tuatahi Fast Fibre, and a number of other private and public sector boards

Glenn Milnes (MBA (Dist.), BSc (Hons), BPhed)

CEO & Managing Director

Glenn Milnes is the CEO and managing director at ikeGPS, where he is accountable for the company's overall strategy, performance, and growth. Prior to leading ikeGPS, Glenn previously held senior executive, strategy and corporate development positions in the Communications industry with Cable & Wireless International, and with No. 8 Ventures.

Rick Christie / (MSc (Hons) Chemistry)

Independent Director

Rick Christie is the former Chairman of Ebos Group, where he was Chair through much of its growth to become a >\$3B business today. He has experience on a number of other major boards, including TVNZ. Rick was previously CEO of investment company Rangatira Ltd and had 20 years' executive management experience in the international oil & gas industry.

Fred Lax / (MSEE and BSEE)

Independent Director

Fred Lax is an executive leader with extensive global experience in the telecommunications industry and related technologies. Based in California, he is a former director of NASDAQ listed Ikanos Communications Inc. (acquired by Qualcomm Atheros), and former Chief Executive Officer and President of NASDAQ listed Tekelec Inc.

Technology and solutions

A Full Stack of Pole and OSP Products & Solutions



Pole loading analysis through PoleForeman and Sagline

Standardized digitization and field data collection methods, with dashboard reporting

Bulk data and image processing using low-code artificial intelligence for distribution utility assets



Technology & automation driven service providing pre-packaged data to accelerate engineering





Business model upshot:

- A recurring Subscription to access any IKE Solution
- Additive, reoccurring Fees based on usage
- Optional value-added products , such as IKE Analyze and IKE University



Our Solutions

Pole Specific Field Tools and Cloud Software

The IKE Office solution combines the IKE Device and IKE Office Pro cloud software to let you standardize data and create accurate pole records fast.



Industry Standard Pole Load Analysis

IKE Structural gives you access to PoleForeman, the industry leading pole load analysis software used by the largest electric utilities in North America.



Bulk Data and Image Processing using Artificial Intelligence for any utility asset

IKE Insight is a technology that combines AI, machine learning, conditional learning, and predictive analytics to create actionable insights from any data or image source.





Building the PoleOS™ Company

IKE is executing a rolling 12-quarter plan against three strategic swim lanes, to create long term differentiation

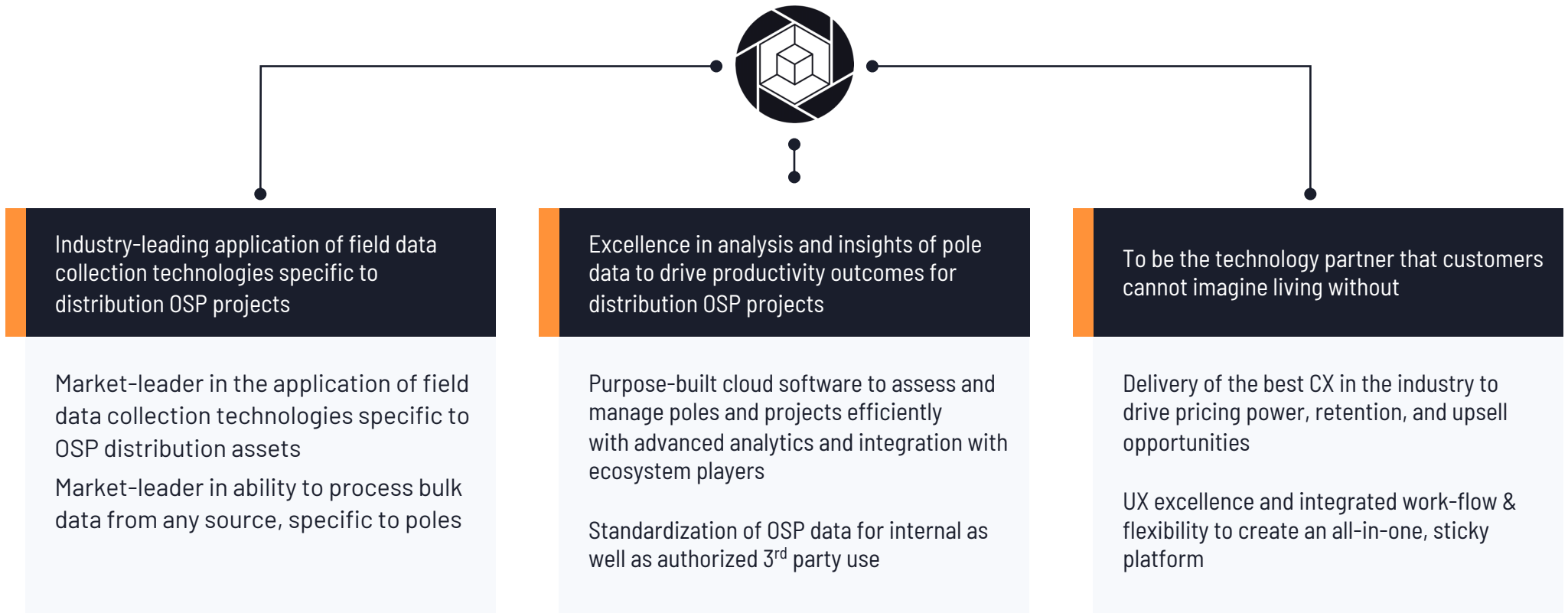



IKE Office Pro

Standardized Field Data Collection with
Back Office Cloud Analysis and Project
Dashboards





IKE Office Pro

Standardized Field Data Collection with Back Office Cloud Analysis and Project Dashboards

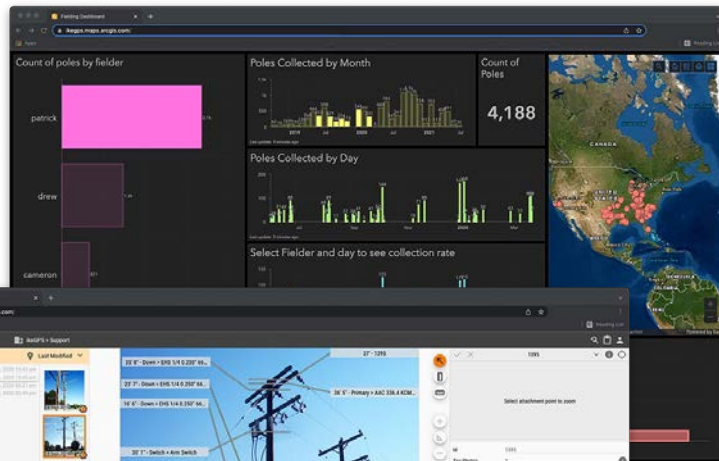

Simplify field data collection with the Android IKE Device and send the data right into IKE Office Pro

With your data in the cloud your options are limitless



Data export to 100s of file types supporting Self Performance or ESP-led Engineering Services

The IKE Office solution enables customers to standardize workflows and create accurate, digitized pole records fast

- Field data collection workflow platform
- Back-office analysis software
- Real-time productivity dashboards

Delivering dramatic productivity improvements: data quality, speed, reduced re-work, and team safety



IKE Analyze

A service providing pre-packaged data to accelerate engineering services

- IKE Reports
- PLA Reports
- MRA Improvements
- Pass/Fail Maps
- IKE Office Cloud Database
- IKE Photo Records
- Permitting
- Audit with GPS or Image
- Etc.



Digitization via IKE Office Pro Cloud Software

Export data through various methods and various workflows

Supporting Customer Workflows

- IKE Report
- Permitting
- Pole Loading Analysis
- Joint Use

Export

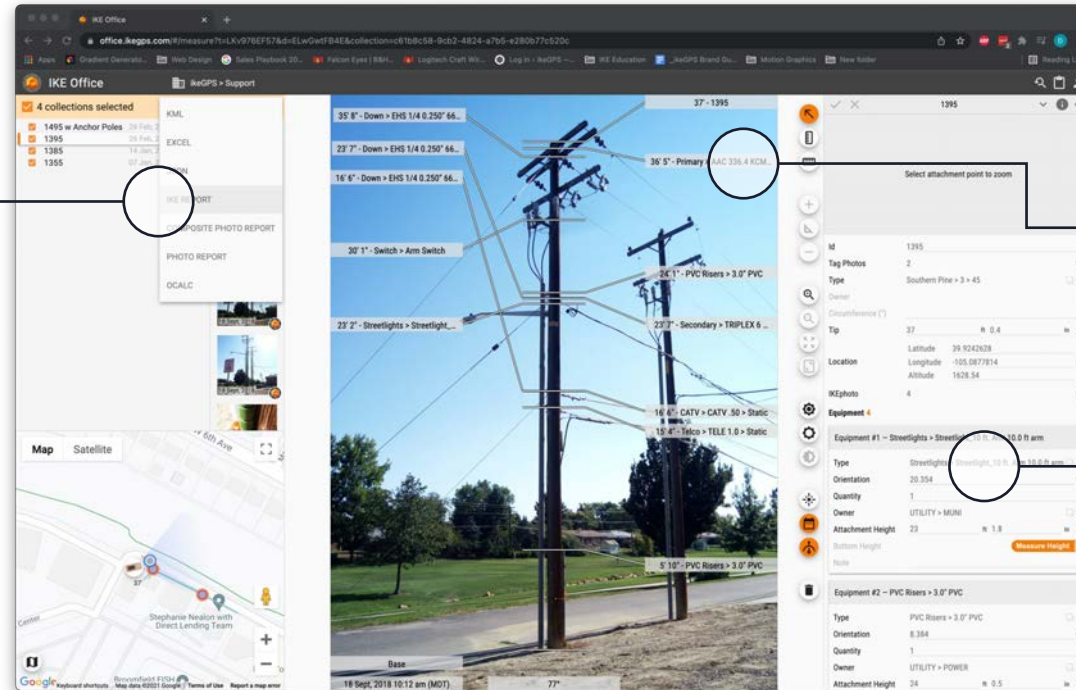

Measure poles, spans, equipment, and location

Full integration to automate pole load analysis



Automate and Integrate with Cloud Software Capabilities

The image displays the IKE Office Pro software interface across three devices: a desktop monitor, a laptop, and a tablet. The desktop monitor shows a detailed view of a utility pole with various equipment and a data table. The laptop displays a dashboard with several charts, including a bar chart for 'Count of Pole by Fielder', a bar chart for 'Poles Collected by Month', and a bar chart for 'Poles Collected by Day'. The tablet shows a map view with a list of poles and their details. Three callout boxes point to specific features:

- Drag and drop form builder to make custom forms and standardize team workflows** (points to the form builder interface on the desktop monitor)
- Standardize engineering team workflows across infrastructure owners** (points to the dashboard charts on the laptop)
- Pole loading analysis integration** (points to the map view on the laptop)



Dramatic Productivity Benefits for Customers

Standardize the quality of field work



Whole-of-network project view



Detailed digitization of assets via digital twins

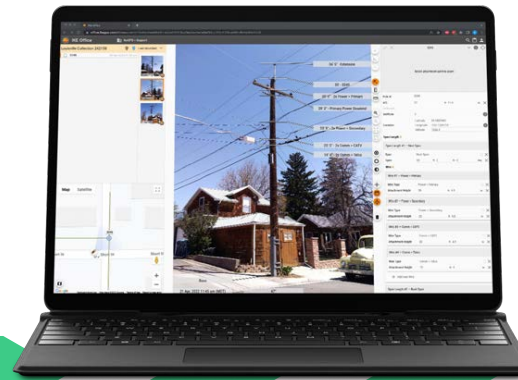

Real time, customized dashboards to optimize project management





IKE Structural

PoleForeman is one of the four standards for Pole Loading Analysis in North America

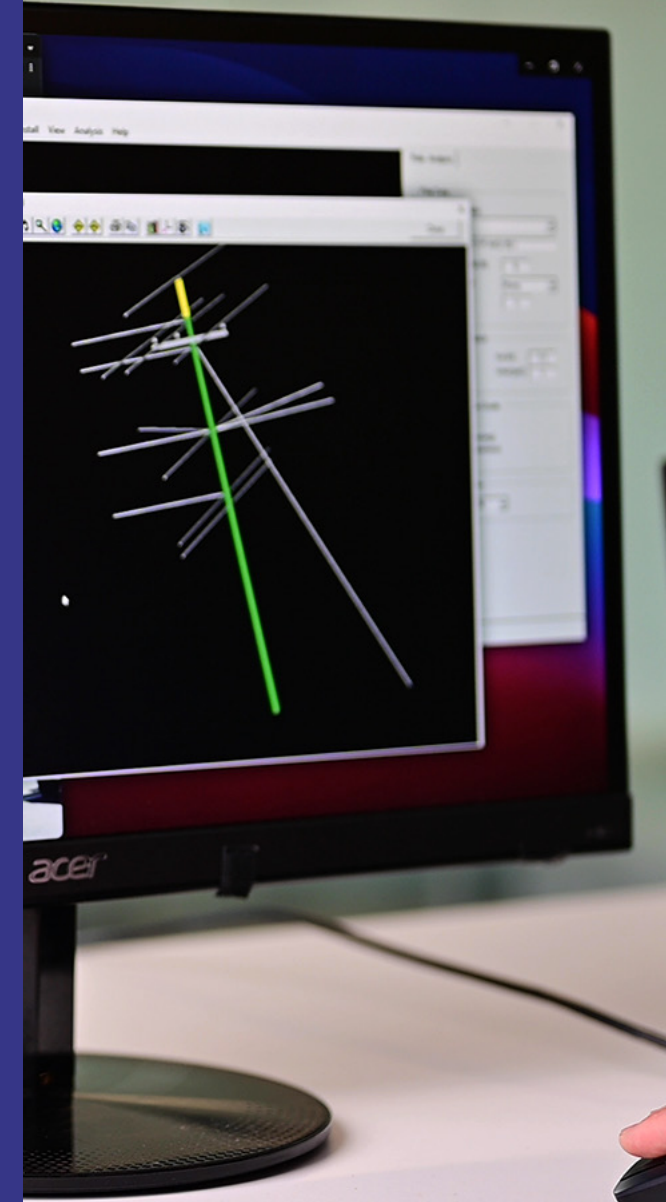



IKE Structural



Integrates with existing client's pre-built databases, custom database requests, or RUS (Rural Utilities Service) databases

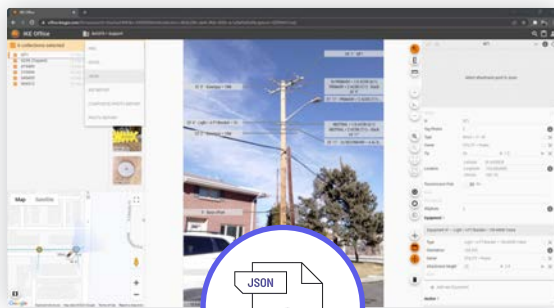

PoleForeman is one of the four standards for Pole Loading Analysis in North America

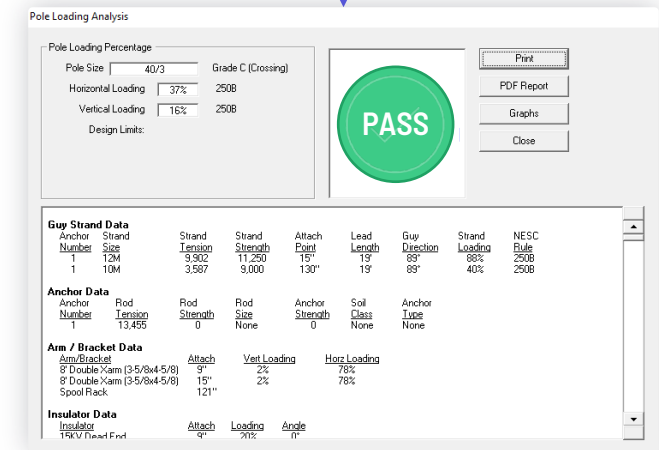
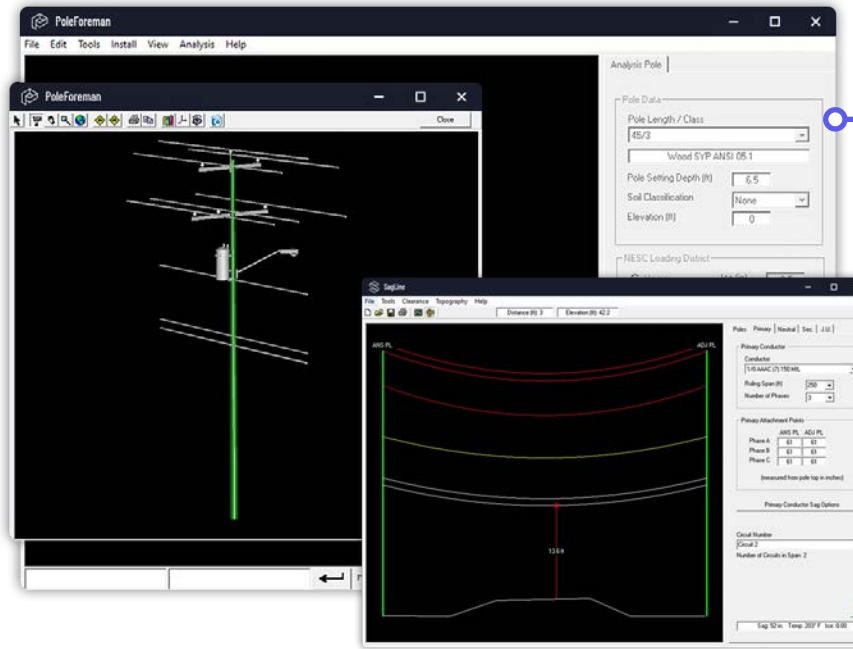

Find out quickly whether your poles pass or fail and easily export the results via the Pole Loading Analysis summary screen



PoleForeman

&



SagLine



PoleForeman Capability....

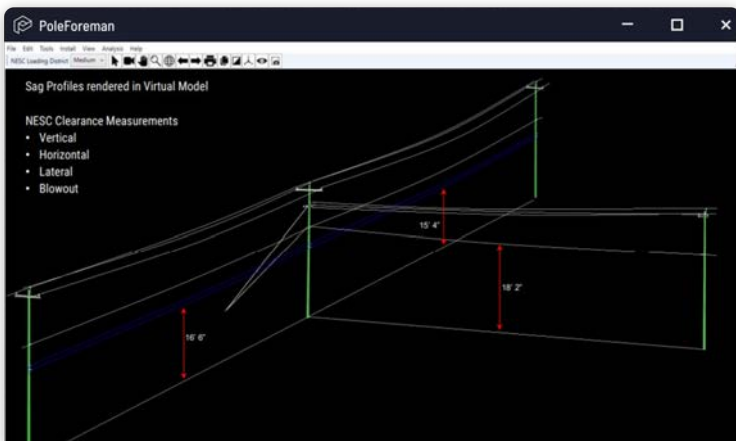

Structural analysis and 3D modelling

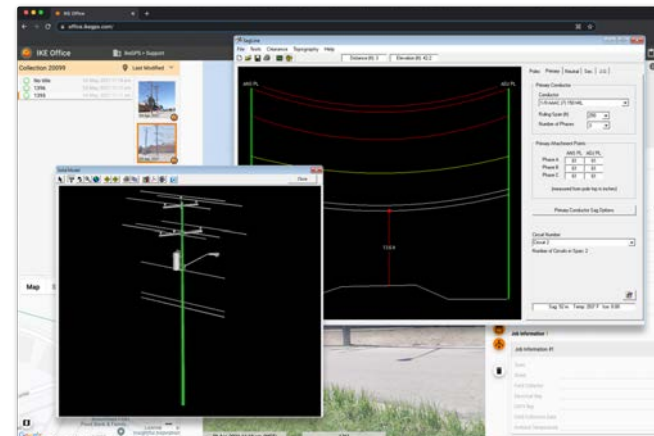

Measure clearances

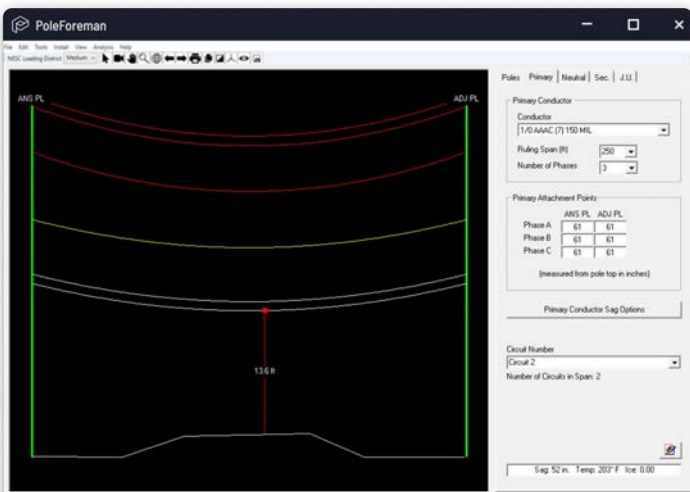

Ensure structural integrity and NESC compliance

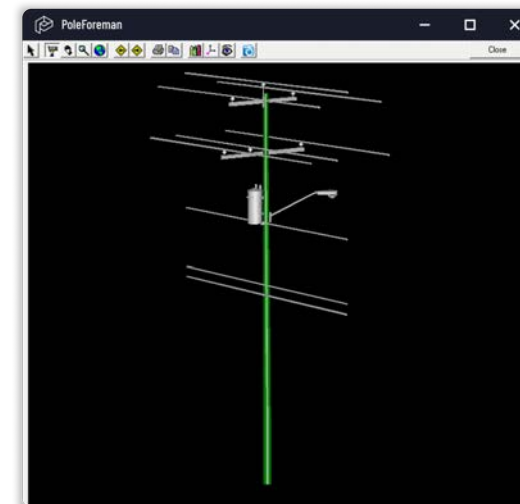

Scaled 3D renderings

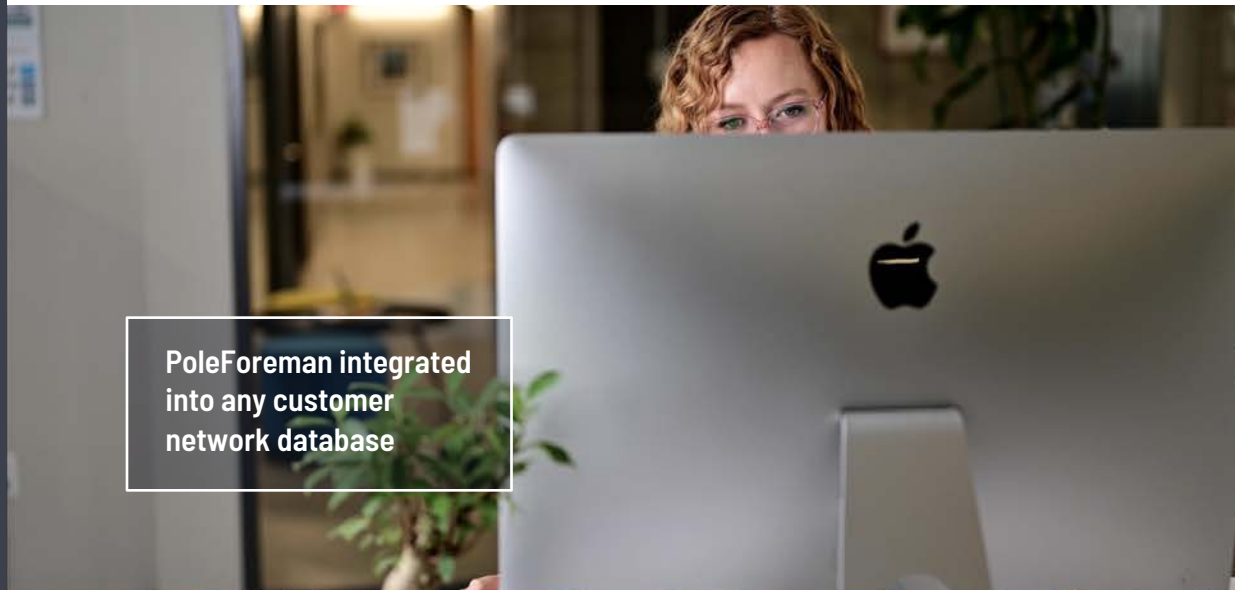

PoleForeman integrated into any customer network database

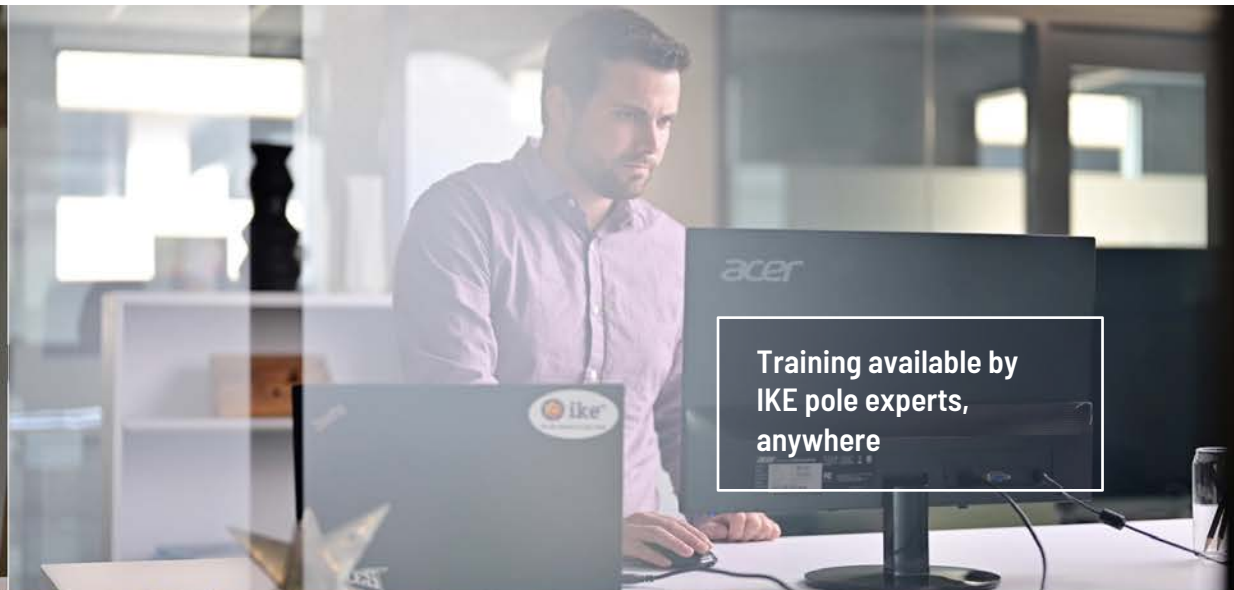

Training available by IKE pole experts, anywhere



Deployed at the largest IOU's and Electric Co-ops in the U.S.

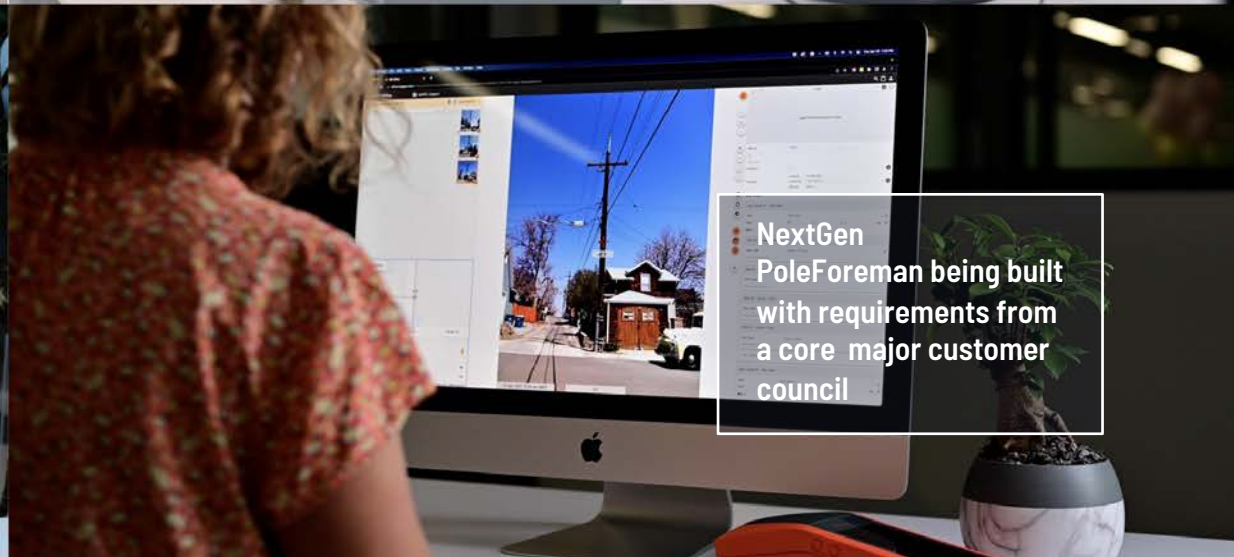

NextGen PoleForeman being built with requirements from a core major customer council

The NextGen PoleForeman Solution Will Deliver Key Differentiation to the Market

To be released 2023, designed with a customer council including the Standards Group leaders within:





IKE Insight

Bulk data and image processing using low-code artificial intelligence for distribution utility assets





IKE Insight

Bulk data and image processing using low-code artificial intelligence for distribution utility assets

IKE Insight allows access to pole imagery from anywhere and for any reason

Industry Use Cases

- Utility pole audits
- Pole inspections
- Line degradation and vulnerabilities
- New insights from legacy audits
- Quality assurance
- Pole ownership
- Location validation

Field Data Collection Agnostic



Existing Data Images



Drones



Thermal Imagery



Field Devices



Lidar



Satellite

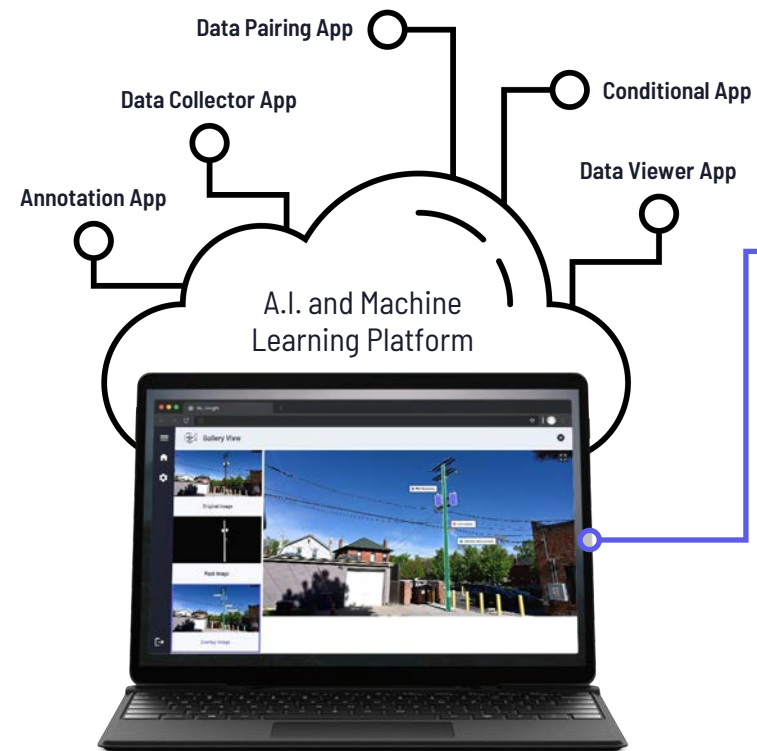

IKE takes pole images and imports them into IKE Insight A.I. and Machine Learning apps to conduct analysis

Use the analysis to get the actionable insights

NESC Violation Extraction

Measurement between 2 static objects

Measurement between dynamic objects

As-builts for future change detection

ROW Management

Pole Segmentation





IKE Insight Introduces a Range of Disruptive Capabilities

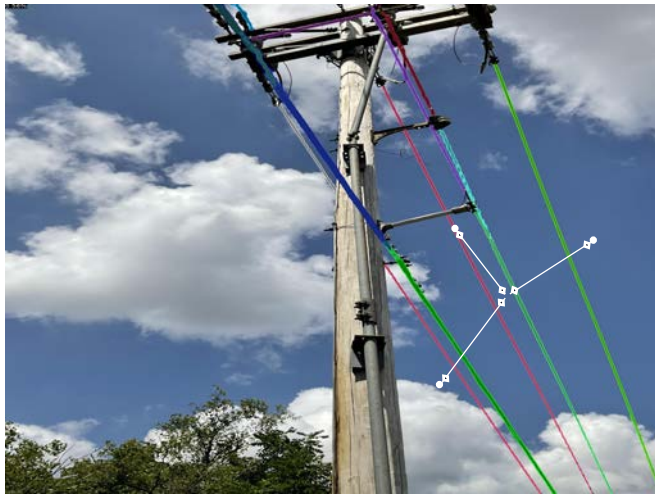

Automated instance segmentation models for poles



Accurate pole detectors, and auto-generated photo-realistic models



Text-based enquiry of bulk data to be 'the Google' for search of distribution networks

(example search above: "Birds on Wire")



IKE Analyze

Pole & Engineering Analysis





IKE Analyze

Pole Analysis from IKE experts, software and automation. Customers collect the distribution network data. IKE performs the engineering analysis

For customers: Faster engineering, dramatic scale, profitability, and efficiency benefits

Example Deliverables:

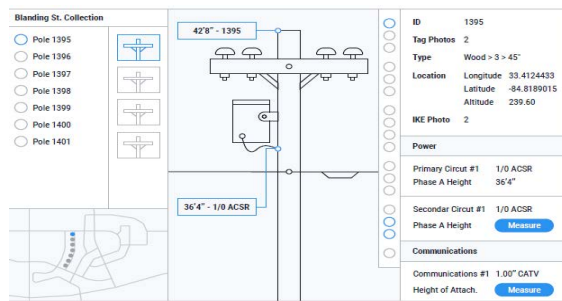

Height of Attachments (HOA)
engineering deliverable example

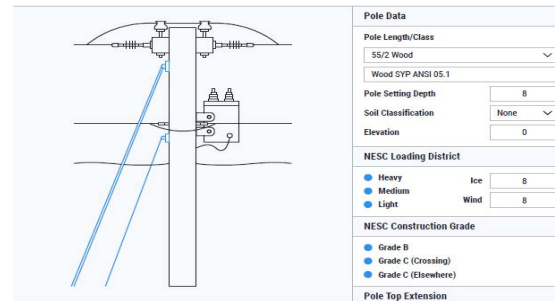

Pole Load Analysis (PLA) engineering
deliverable example

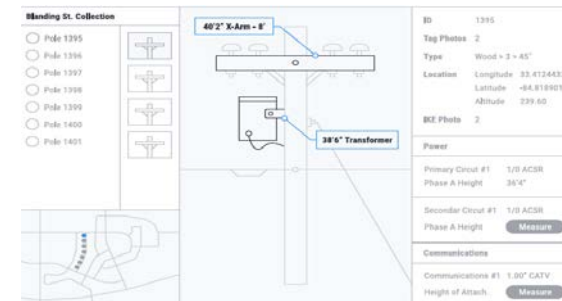

Make Ready Recommendations (MRR)
engineering deliverable example

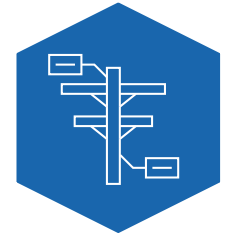



IKE Analyze

IKE Analyze Improves Resource Optimization, Drives Scale, Reduces Costs and Increases Profit





Thanks

Manaakitanga: We Rise By Lifting Others

